

RevNo	Revision note	Date	Signature	Checked
-------	---------------	------	-----------	---------

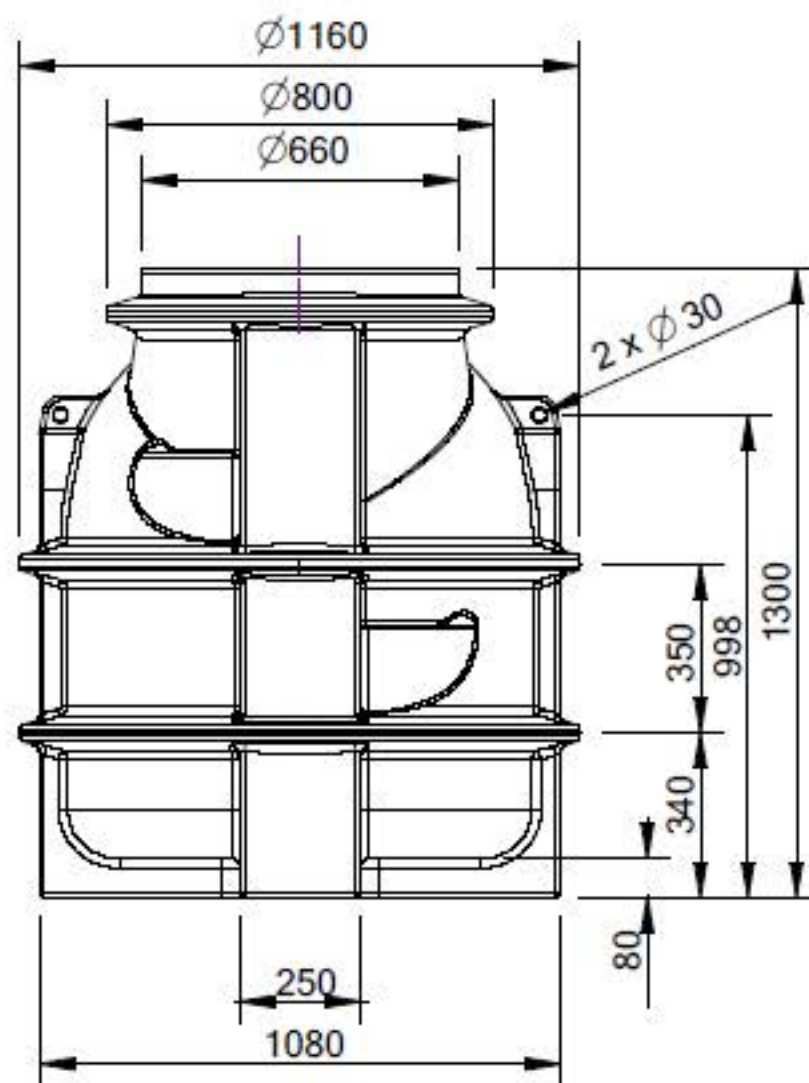
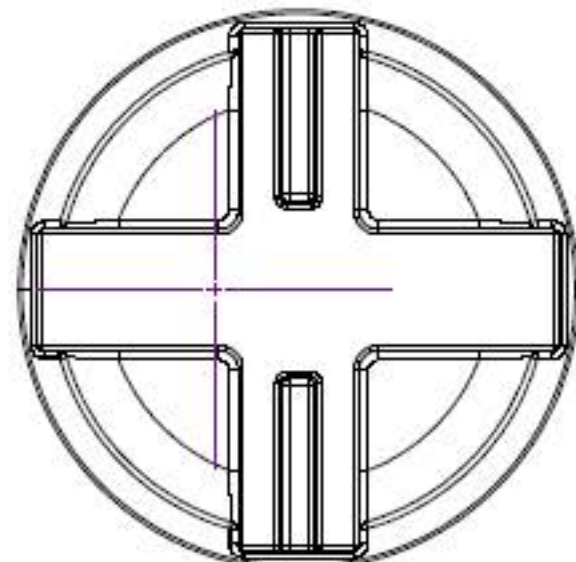
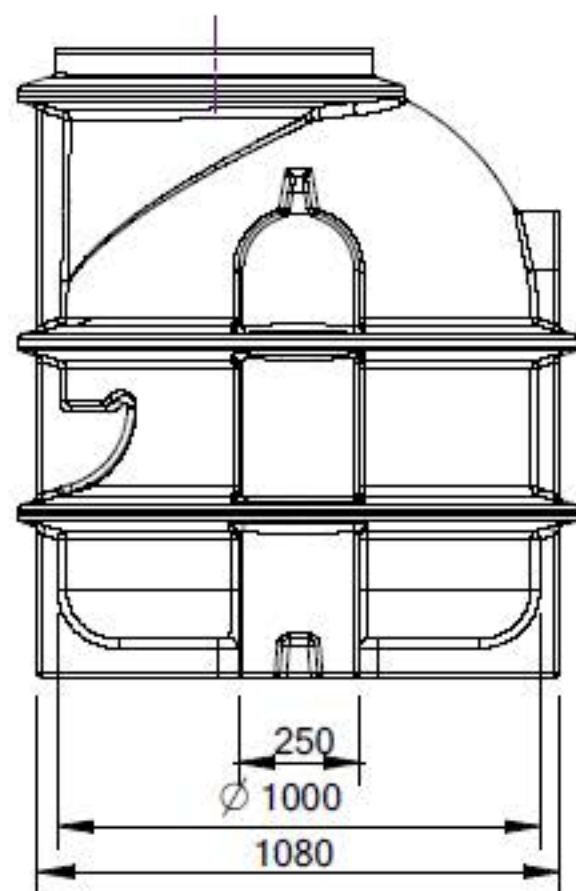
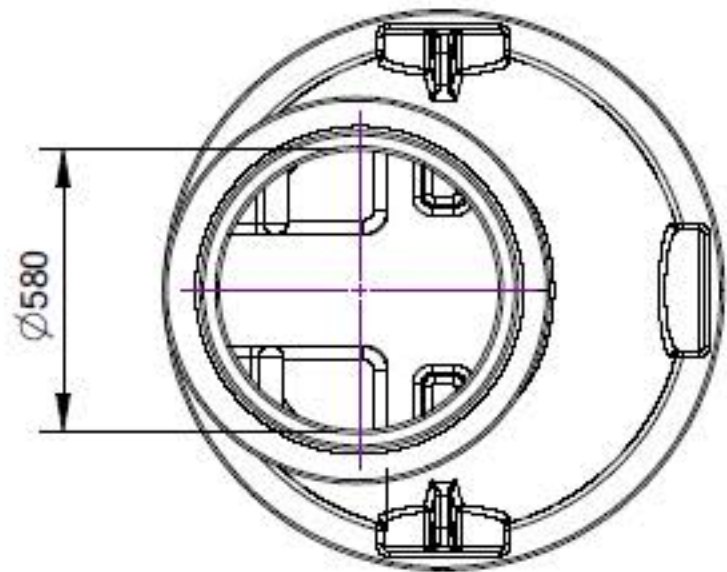

Itemref	Quantity	Title/Name, designation, material, dimension etc PE 50kg, 1 m3	Article No./Reference		
Drawn by Ing. Jan Burian	Checked by	Approved by - date	File name	Date 08.11.2020	Scale 1:1

ROTO-V-1000/1300

Edition Sheet
1 OF 1